

SPECIFICATION
FOR
SWITCHING POWER SUPPLY

M/N: MPM-S055

Revision History

Version	Date	Change Items
Rev. 01	June.21. 2017	Established.
Rev. 02	Dec.29. 2017	Engineering.
Rev. 03	Sep.17. 2018	Added metal plate description.



FEATURES

- ✓ 60W air cooling / 50W convection-cooled @ 50°C ambient.
- ✓ Wide operating temperature -20~80°C.
- ✓ Compact size 2" x 3" with low profile 1".
- ✓ High efficiency up to 88%.
- ✓ No-load power consumption < 0.3W.
- ✓ Designed to meet medical standard IEC, EN, UL 60601-1, type BF rated patient contact leakage current.
- ✓ Meets EMI CISPR 11 / FCC Part 18 class B.



Models & Ratings

Model Number	Wattage (Rated / Max)	Output Voltage	Min. Current	Rated Current	Max. Current
MPM-S055	50 W / 60 W	+24 V	0 A	2.08 A	2.5 A

Note:

1. Total Output Power: Rated 50W convection cooled, above 51~60W with 13.6 CFM forced air-cooling at 50°C environment temperature. Please see detail performance curves as below.

Summary

Characteristic	Minimum	Typical	Maximum	Units	Notes & Conditions
Input Range	85	115 / 230	264	VAC	Universal input range.
Input Frequency	47	50 / 60	63	Hz	AC input.
Efficiency		88		%	At input 230VAC, rated load, 1.0 hr. warm up.
Operation Temperature	-20		+80	°C	Derate from 50°C, become 50% load at 80°C.
Weight		103.8		g	
Dimensions	76.2 (L) x 50.8 (W) x 25.6 (H) mm, Tolerance +/- 0.5mm.				
EMC	EN 55011, EN 60601-1-2, EN 61000-3-2, EN 61000-3-3, IEC 61000-4-2, IEC 61000-4-3, IEC 61000-4-4, IEC 61000-4-5, IEC 61000-4-6, IEC 61000-4-8, IEC 61000-4-11				
Safety Approvals (Pending)	IEC 60601-1, EN 60601-1, ANSI/AAMI ES60601-1, CAN/CSA-C22. 2 No. 60601-1				

Input

Characteristic	Minimum	Typical	Maximum	Units	Notes & Conditions
Input Voltage	85	115 / 230	264	VAC	Universal input range.
Input Frequency	47	50 / 60	63	Hz	AC input.
Input Current			1.5 / 0.8	A	Nominal AC Input Voltage (115VAC/230VAC), rated load.
Inrush Current			30 / 60	A	Nominal AC Input Voltage (115VAC/230VAC), one cycle at 25°C cold start.
Leakage Current		100 / 300		μ A	Normal Condition / Single Fault Condition.
No-load power consumption		0.3		W	Nominal AC Input Voltage (115VAC/230VAC).
Input Protection	Dual non-user serviceable internally located AC input line fuse. Fuse : 2A / 250VAC * 2pcs				

Output

Characteristic	Minimum	Typical	Maximum	Units	Notes & Conditions
Output Voltage		24		VDC	
Initial Set Accuracy		\pm 3		%	Initial setting accuracy is adjusted at input 115VAC and output at 60% rated load.
Minimum Load		0		A	
Start Up Delay		3 / 1.2		Sec.	Time required for initial output voltage stabilization. Nominal AC Input Voltage (115VAC/230VAC), rated load at 25°C.
Hold Up Time		12 / 60		mS	Nominal AC Input Voltage (115VAC/230VAC), rated load.
Line Regulation		\pm 0.5		%	Less than \pm 1% at rated load with \pm 10% changing in input voltage.
Load Regulation		\pm 1		%	Measured from 60% to 100% rated load and from 60% to 20% rated load (60% \pm 40% rated load).
Ripple & Noise		100		mV	Measured at rated load by a 20MHz bandwidth limited oscilloscope and each output is connected with a 10 μ F Electrolytic Capacitor and a 0.1 μ F Ceramic Capacitor.
Overvoltage Protection	For some reason the power supply fails to control itself, the build-in over voltage protection circuit will shut down the outputs to prevent damaging external circuits.				
Overload Protection	Auto recovery.				
Short Circuit Protection	Fully protected against output overload and short circuit. Automatic recovery upon of overload condition.				

General

Characteristic	Minimum	Typical	Maximum	Units	Notes & Conditions
Efficiency		88		%	At input 230VAC, rated load, 1.0 hr. warm up.
Isolation IP to OP	4000			VAC	2 x MOPP
MTBF		380,000		hrs.	MIL-HDBK-217F at 25°C

Environmental

Characteristic	Minimum	Typical	Maximum	Units	Notes & Conditions
Low temperature start up	-20			°C	Some specification parameters maybe exceeded until after 20 minutes warm up period. ^(Note 1)
Operating Temperature	-20		+80	°C	Derate from 50°C, become 50% load at 80°C.
Storage Temperature	-40		+85	°C	
Relative Humidity	5		95	%RH	Non-condensing.
Cooling	13.6			CFM	Forced-cooled > 50W
Operating Altitude		3000		m	
Vibration	0.26		6.09	G	Frequency Type: Sweep Frequency Frequency Range: 10~55 Hz Displacement: 1.0mm Sweep Rate: 60 minute / cycle Number of cycle: 1 cycle / axis Direction: X ,Y and Z axis

Note:
1. To start up at low temperature, when the $V_{IP} < 115VAC$, please set the rated load @ 10% for maximum; when $115VAC < V_{IP} < 230VAC$, please set the rated load @ 30% for maximum; when $V_{IP} \geq 230VAC$, there will be no specific limitation on rated load setting.

Derating curve

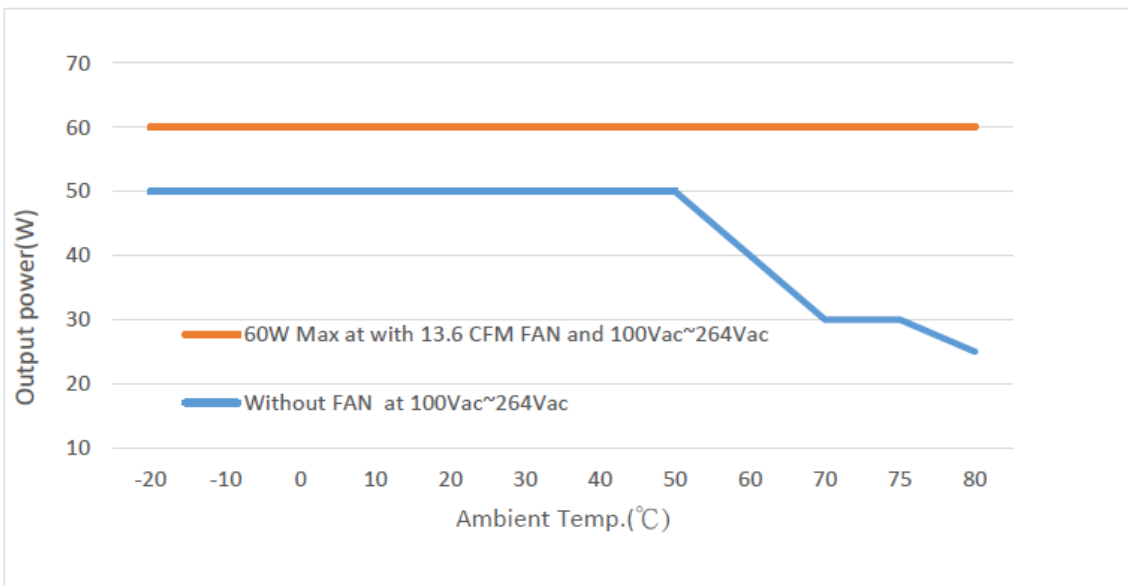
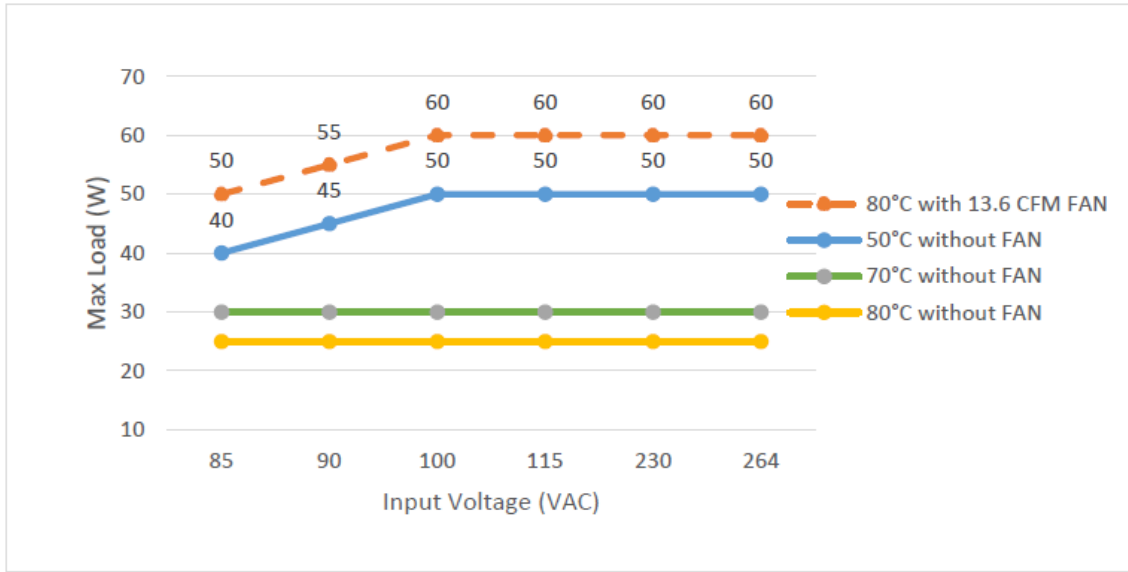

EMC: Emissions

Phenomenon	Standard	Class	Notes & Conditions
Conducted	EN 55011 / CISPR 11 & FCC Part 18	B	1. Pass without enclosure. 2. Pass with or without a metal plate below the power supply.
Radiated	EN 55011 / CISPR 11 & FCC Part 18	B	
Harmonic Current	EN 61000-3-2	A	
Voltage Flicker	EN 61000-3-3		

- Note:
- Above specification is applied with output equal or below 50W. For higher output power, please re-confirm with us.
 - Above specification is based on the test conditions of EN 55011 / CISPR 11 & FCC Part 18. If there is any question when the power supply is applied to the system, please contact us for assistance.
 - Pass EMI with or without a metal plate below the power supply. If you want to use a metal plate under this power, the distance in between accessible metal part needs to add at least 4mm of 1xMOPP to meet Class II.

EMC: Immunity

Phenomenon	Standard	Criteria	Notes & Conditions
ESD	IEC 61000-4-2	A	±15KV air discharge, ±8KV contact discharge
Radiated	IEC 61000-4-3	A	10V/m
EFT	IEC 61000-4-4	A	±2KV L-N, 100KHz
Surges	IEC 61000-4-5	A	L-N:±1KV
Conducted	IEC 61000-4-6	A	10V
Power Magnetic	IEC 61000-4-8	A	30A/m
Dips and Interruptions	IEC 61000-4-11	A A / B A B	DIP: =100%, 0.5 cycle DIP: =100%, 1 cycle ^(Note 2) DIP: =30%, 25 cycles INT: =100%, 5sec

- Note:
- Above specification is applied with output equal or below 50W. For higher output power, please re-confirm with us.
 - The test result of input 240Vac / 100Vac is criteria A / B.

Safety Approvals

Safety Agency	Safety Standard	Notes & Conditions
TUV	EN 60601-1: 2006+A11+A1+A12	Designed to meet (Medical 3.1 rd)
CB	IEC 60601-1: 2005+CORR. 1: 2006+CORR. 2: 2007+A1: 2012	
UL/cUL	ANSI/AAMI ES60601-1, CAN/CSA-C22. 2 No. 60601-1	

Mechanical Details

Mechanical Specification

Parameter	Conditions/Description				
Dimension	76.2 (L) x 50.8 (W) x 26.1 (H) mm, Tolerance +/- 0.5mm.				
Connector & Pin Assignment	Location	Pin	Assignment	Proposed Housing	Proposed Terminals
CN1 (Input)	MX1	JT3	AC in (N)	Mates with Molex 09-50-1031 or Equivalent. When used model no. suffixed -J mates with JST VHR-3N or Equivalent.	Molex series 5194 crimp terminal or equivalent. When used model no. suffixed -J mates with JST series SVH-21T-P1.1 crimp terminal or equivalent
	MX2	JT2	Empty		
	MX3	JT1	AC in (L)		
CN2 (Output)	MX1	JT2	+ V	Mates with Molex 09-50-1021 or Equivalent. When used model no. suffixed -J mates with JST VHR-2N or Equivalent.	Molex series 5194 crimp terminal or equivalent. When used model no. suffixed -J mates with JST series SVH-21T-P1.1 crimp terminal or equivalent
	MX2	JT1	0 V		

Note: Exist with model no. suffixed -J

Mechanical Drawing

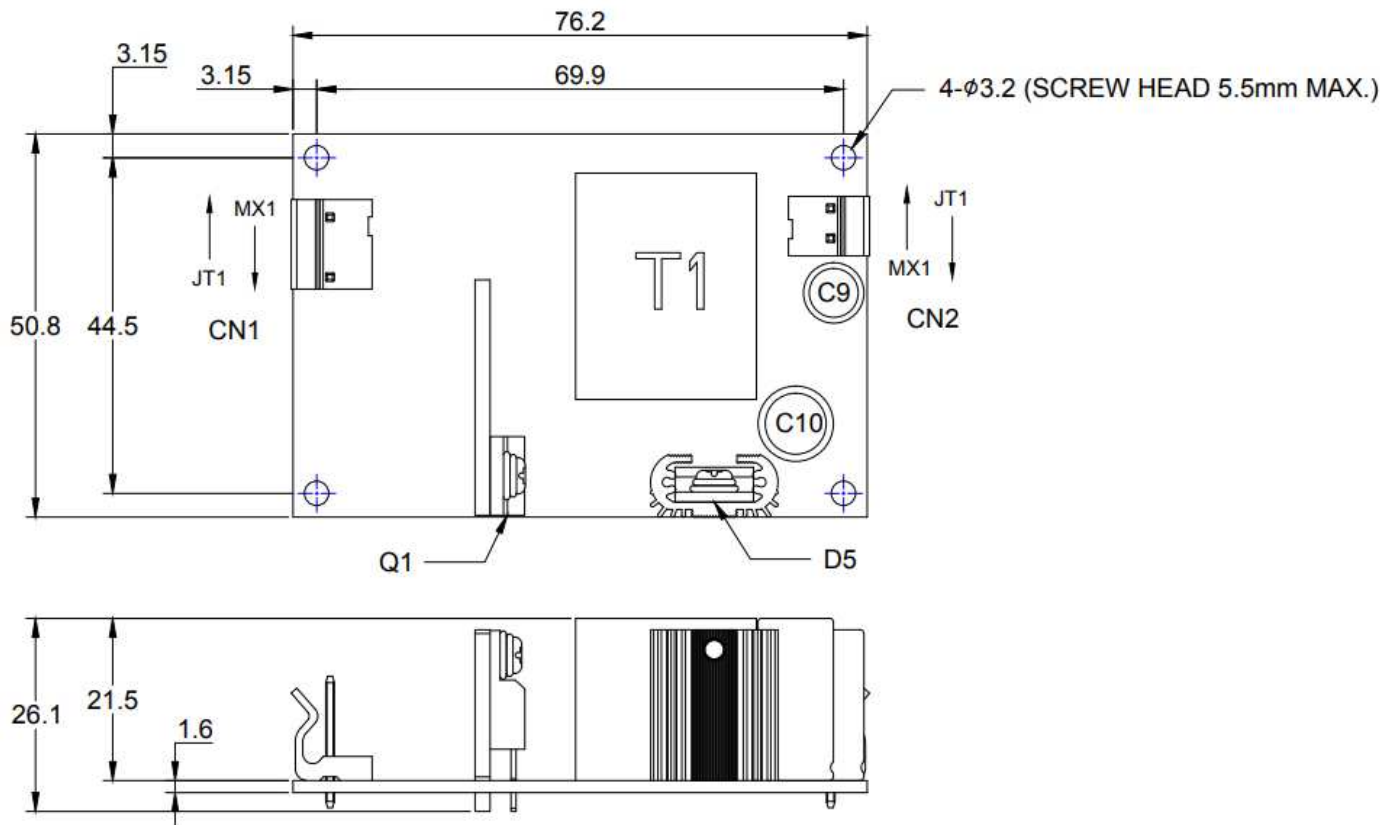

Performance

(Input voltage: 115Vac)

Switching frequency ripple rated load

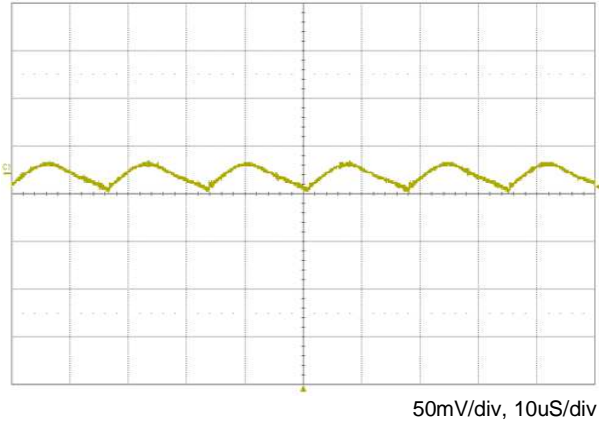

Line frequency ripple rated load

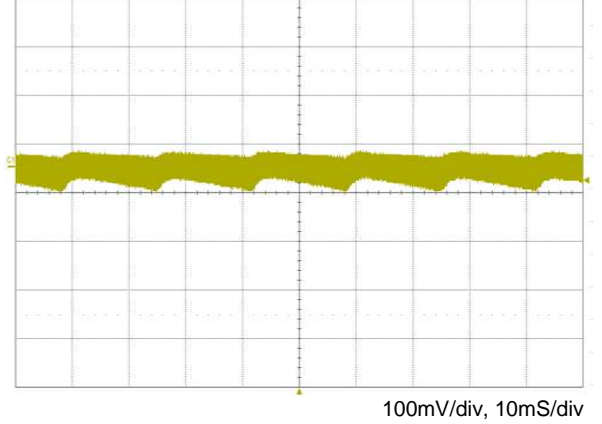

Output turn-on rated load

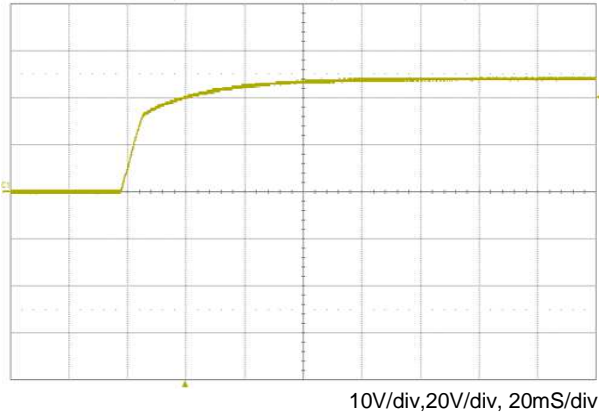

Output turn-off rated load

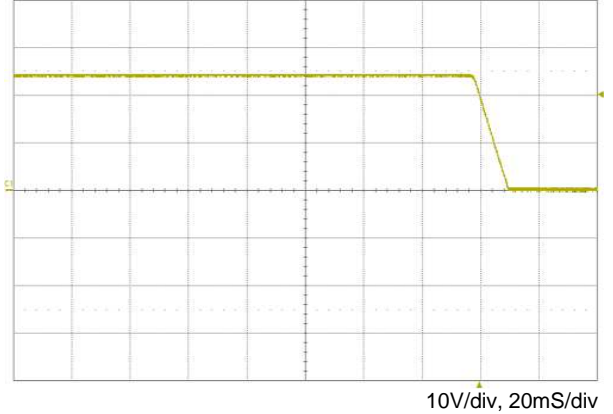

Hold-up time rated load

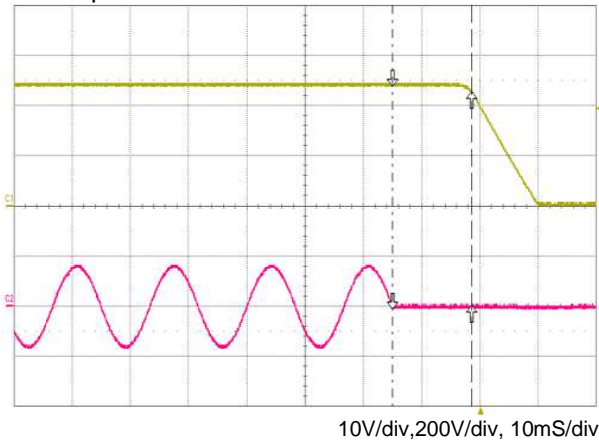

OVP 60% of rated load

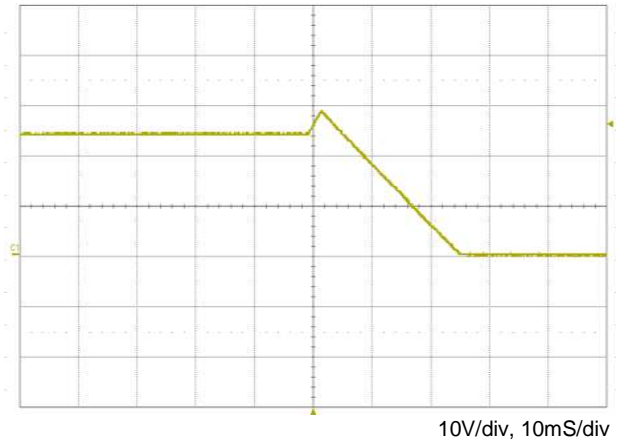

Step response 20%~100% of rated load

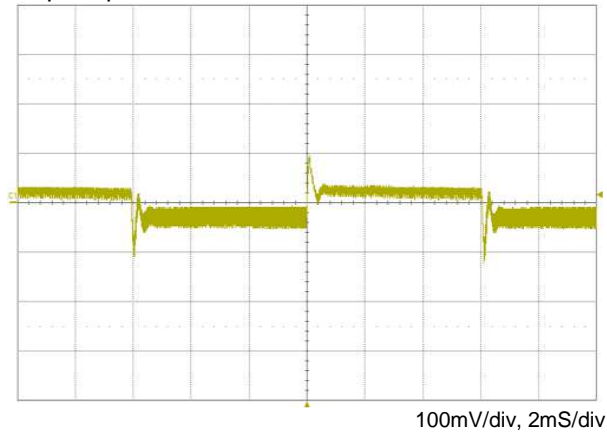

EMI: EN55011 "B" (Conduction)

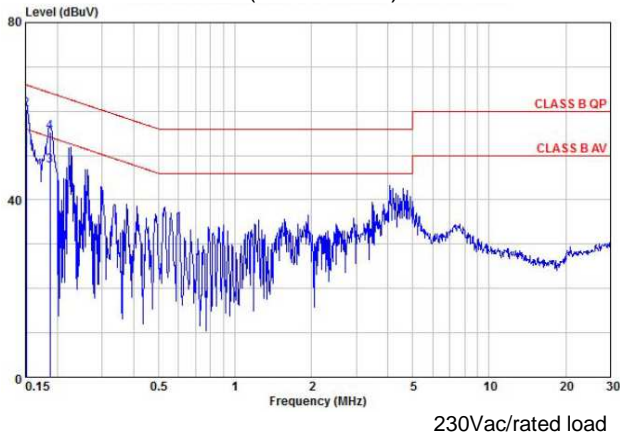

EMI: FCC "B" (Conduction)

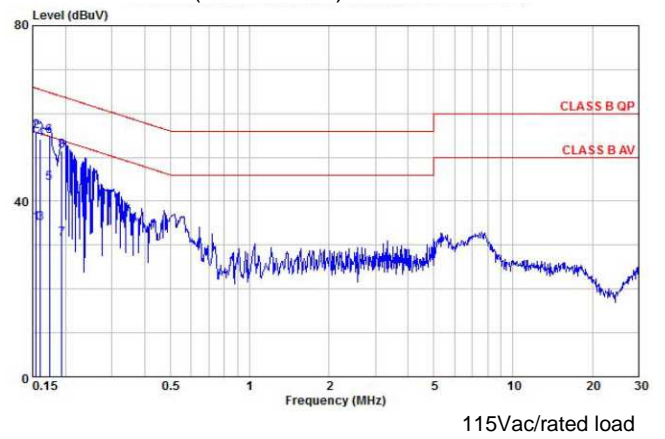

EMI: EN55011 "B" (Radiation)

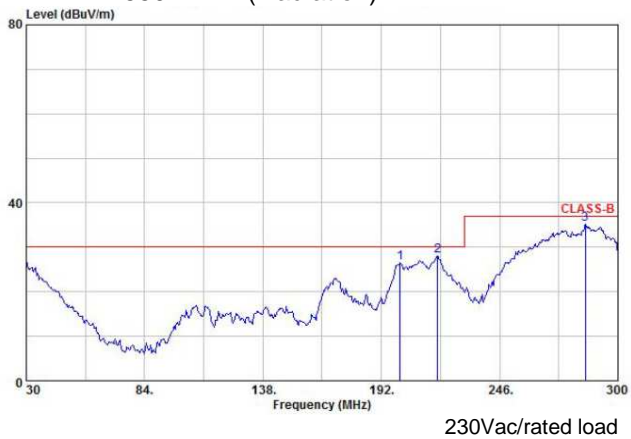

EMI: FCC "B" (Radiation)

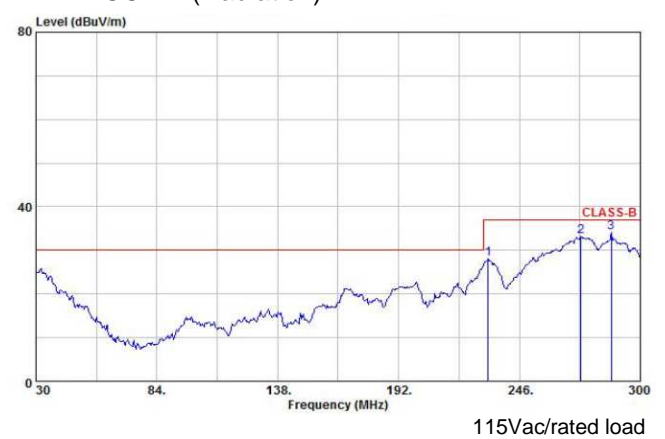

Thermal Considerations

In order to ensure safe operation of the SPS in the end-use equipment, the temperature of the components listed in the table below must not be exceeded.

Temperature should be monitored using J type thermocouples placed on the hottest part of the component (out of any direct air flow). See mechanical details for component locations.

Temperature measurements at monitored amb.	
Component	Monitored Temperature
T1	120°C
Q1	118°C
D5	114°C
C9	104°C
C10	94°C