

**SPECIFICATION**  
**For**  
**SWITCHING POWER SUPPLY**

**M/N: MPE-S206 (48V / 4.16A)**

### Revision History

Version	Revise Date	Change Items
Rev. 01	Aug. 24. 2020	Established.

# MPE-S206

48V / 4.16A AC / DC



## FEATURES

- ✓ 200W with forced-air cooling.
- ✓ 150W convection-cooled.
- ✓ Compact size 2" x 4".
- ✓ No-load power consumption < 0.15W.
- ✓ IEC62368-1, UL62368-1 Approved.
- ✓ Meets EMI CISPR / FCC class B.



### Models & Ratings

Model Number	Wattage (Rated / Max)	Output Voltage	Min. Current	Rated Current	Max. Current
MPE-S206	150 W / 200 W	+48 V	0 A	3.125 A	4.16 A

Total Output Power: Max. 150W with convection cooled at 50°C environment temperature, Max. 200W with 10 CFM.

Model no. coding:

**M P E – S 2 0 6 – X**

<b>X(Connector Type):</b>	[Blank]	JST Type Connector or equivalent.
		Dinkle P-820W Terminal blocks or equivalent.

### Summary

Characteristic	Minimum	Typical	Maximum	Units	Notes & Conditions
Input Range	85	115 / 230	264	VAC	Universal input range.
Input Frequency	47	50 / 60	63	Hz	At AC input.
Efficiency		92		%	At input 230 VAC.
Operation Temperature	-20*		+80	°C	*Can be started up / activated at -20C. In order to stabilize within specification, it needs to <b>warm up</b> at negative temperature. Please refer to the derating curves.
Weight		205		g	
Dimensions	101.6 (L) x 50.8 (W) x 37.6(H) mm, Tolerance +/- 0.4mm.				
EMC	EN55032, CISPR 22 & FCC Part 15, EN61000-3-2, EN61000-3-3, IEC 61000-4-2, IEC 61000-4-3, IEC 61000-4-4, IEC 61000-4-5, IEC 61000-4-6, IEC 61000-4-8, IEC 61000-4-11				
Safety Approvals	IEC 62368-1, UL 62368-1, 2nd Edition, CSA C22.2 No. 62368-1-14, 2nd Edition				

## Input

Characteristic	Minimum	Typical	Maximum	Units	Notes & Conditions
Input Voltage	85	115 / 230	264	VAC	Continuous input range.
Input Frequency	47	50 / 60	63	Hz	At AC input.
Input Current			2.5 / 1.5	A	Nominal AC Input Voltage (115 / 230 VAC), rated load.
Inrush Current			50	A	Nominal AC Input Voltage (115 / 230 VAC), one cycle at 25°C cold start.
No-load power consumption		0.15		W	Nominal AC Input Voltage (115 / 230 VAC).
Input Protection	One non-user serviceable internally located AC input line fuse. Fuse : T5.0A / 250 VAC * 1pcs				

## Output

Characteristic	Minimum	Typical	Maximum	Units	Notes & Conditions
Output Voltage		48		VDC	
Output Current		3.125	4.16	A	
Initial Set Accuracy		±1.0		%	Initial setting accuracy is at Input 115 VAC and output at 60% rated load.
Minimum Load		0		A	
Start Up Delay		0.2	0.5	Sec	Time required for initial output voltage stabilization.
Hold Up Time		11 / 55		mS	Nominal AC Input Voltage (115 / 230 VAC), rated load.
Line Regulation		±0.5		%	Less than ±0.5% at rated load with ±10% changing in input voltage 115 / 230 VAC.
Load Regulation		±0.5		%	Measured from 60% to 100% rated load and from 60% to 20% rated load (60% ±40% rated load).
Ripple & Noise		240		mV	Measured at rated load and Nominal AC Input Voltage (115 / 230 VAC) by a 20MHz bandwidth limited oscilloscope and the each output is connected with a 10µF Electrolytic Capacitor and a 0.1µF Ceramic Capacitor.
Leakage Current			0.6	mA	At input 264 VAC, 63Hz
Overvoltage Protection	For some reason the power supply fails to control itself, the build-in over voltage protection circuit will Latch-off the outputs to prevent damaging external circuits, the trigger point is around 105%~125% of output voltage.				
Short Circuit Protection	Fully protected against output overload and short circuit. Automatic recovery upon of overload condition.				

## General

Characteristic	Minimum	Typical	Maximum	Units	Notes & Conditions
Efficiency		92		%	At input 230 VAC.
Isolation	IP to OP	3000		VAC	
	IP to GND	1800		VAC	
Switching Frequency		65		KHZ	

## Environmental

Characteristic	Minimum	Typical	Maximum	Units	Notes & Conditions
Operating Temperature	-20*		+80	°C	*Can be started up / activated at -20C. In order to stabilize within specification, it needs to <b>warm up</b> at negative temperature. Please refer to the derating curves as following.
Storage Temperature	-40		+85	°C	
Relative Humidity	5		95	%RH	Non-condensing.
Cooling	10			CFM	
Operating Altitude		5000		M	
Vibration	0.26		6.09	G	Frequency Type: Sweep Frequency Frequency Range: 10~55 Hz Displacement: 1.0mm Sweep Rate: 60 minute / cycle Number of cycle: 1 cycle / axis Direction: X ,Y and Z axis

## Derating curve

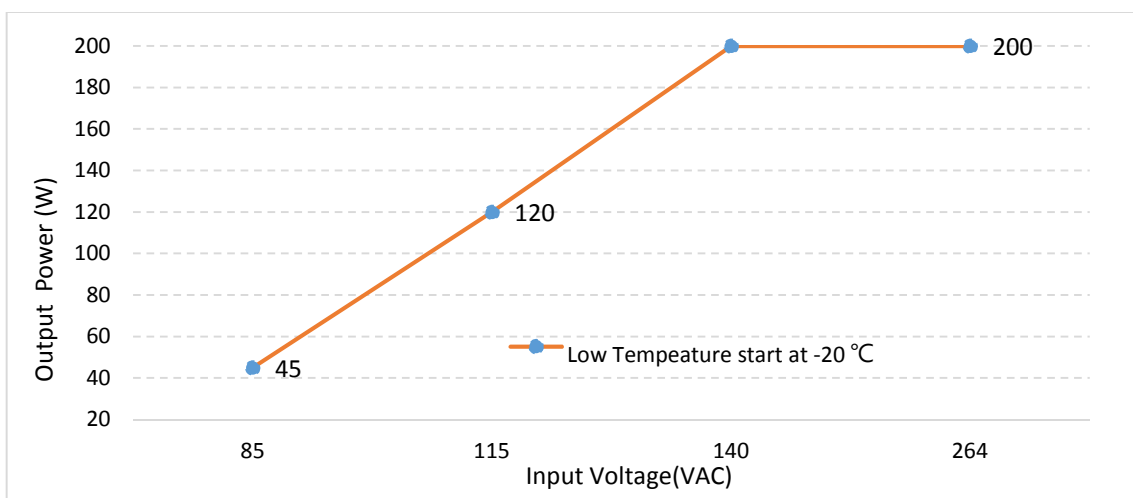
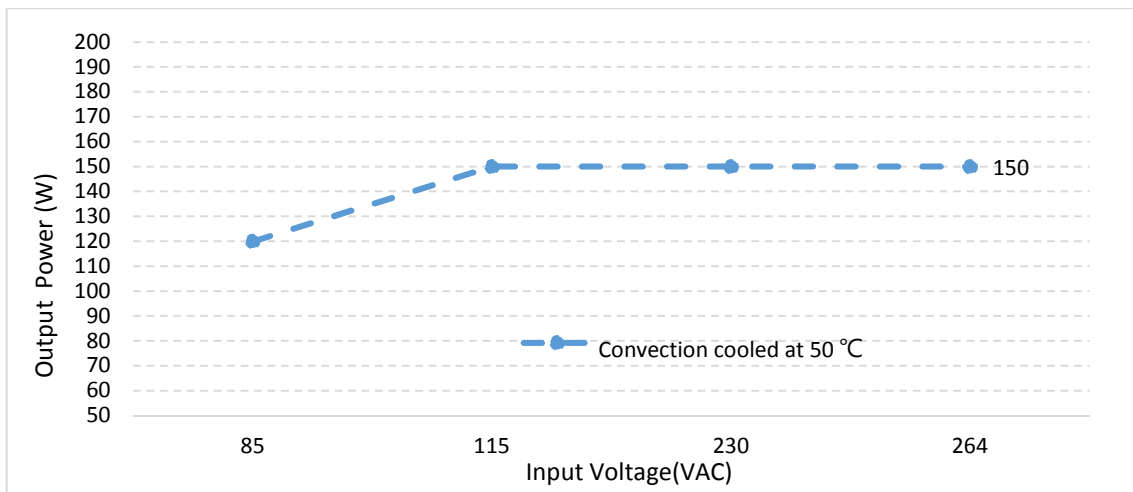
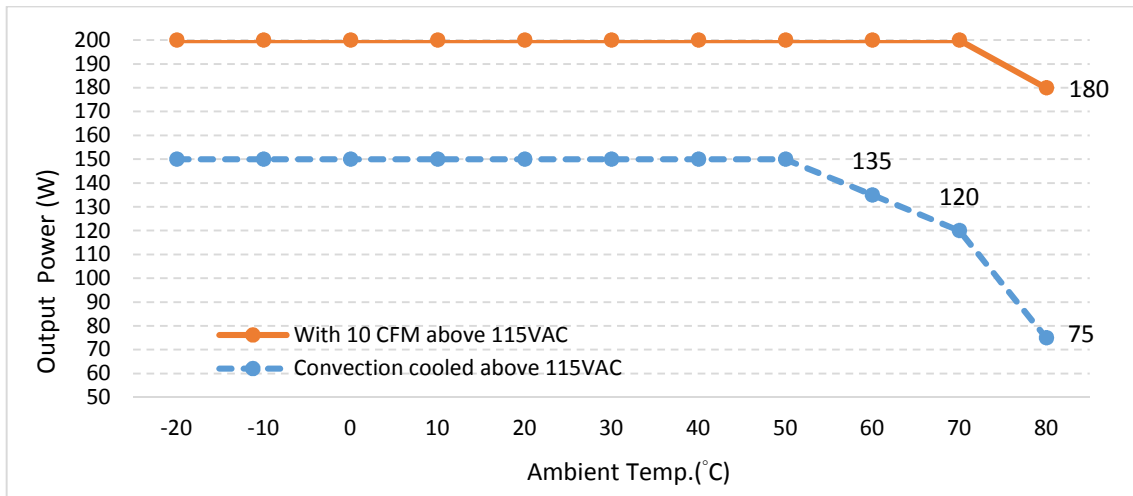

## EMC: Emissions

Phenomenon	Standard	Class	Notes & Conditions
Conducted	EN 55032 / CISPR 32 & FCC Part 15	B	
Radiated	EN 55032 / CISPR 32 & FCC Part 15	B	
Harmonic	EN 61000-3-2	A	
Voltage Flicker	EN 61000-3-3	Pass	

## EMC: Immunity

Phenomenon	Standard	Criteria	Notes & Conditions
ESD	IEC 61000-4-2	A	±8KV air discharge, ±6KV contact discharge
Radiated	IEC 61000-4-3	A	10V/m
EFT	IEC 61000-4-4	A	±2KV Line & PE
Surges	IEC 61000-4-5	A	L-N:±1KV, L/N-PE:±2KV
Conducted	IEC 61000-4-6	A	10V
Power Magnetic	IEC 61000-4-8	A	10A/m
Dips and Interruptions	IEC 61000-4-11	A / B A A / B B	DIP: >95%, 0.5 cycle (Note 1.) DIP: 30%, 25 cycles DIP: 60%, 5 cycles (Note 1.) INT: >95%, 250 cycles

Note:

1. The test result of input 240Vac / 100Vac is criteria A / B.

## Safety Approvals

Safety Agency	Safety Standard	Notes & Conditions
CB	IEC 62368-1, 2nd Edition	Approved.
UL/cUL	UL 62368-1, 2nd Edition, CSA C22.2 No. 62368-1-14, 2nd Edition	Approved.

## Mechanical Details

Unit: mm

SIZE : 101.6(L) x 50.8(W) x 37.6(H)mm, Tolerance +/-0.4mm.

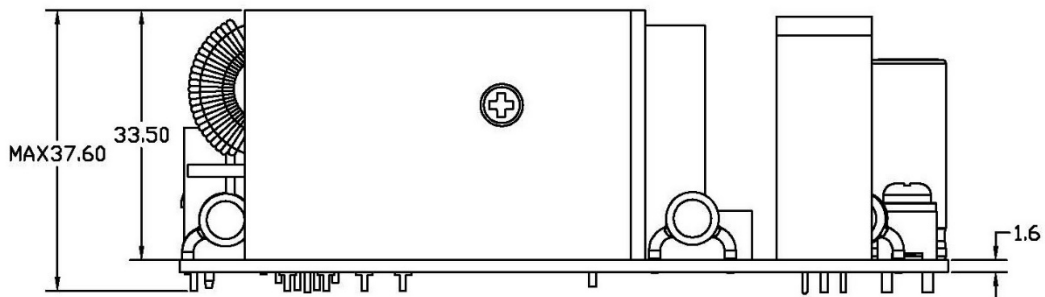
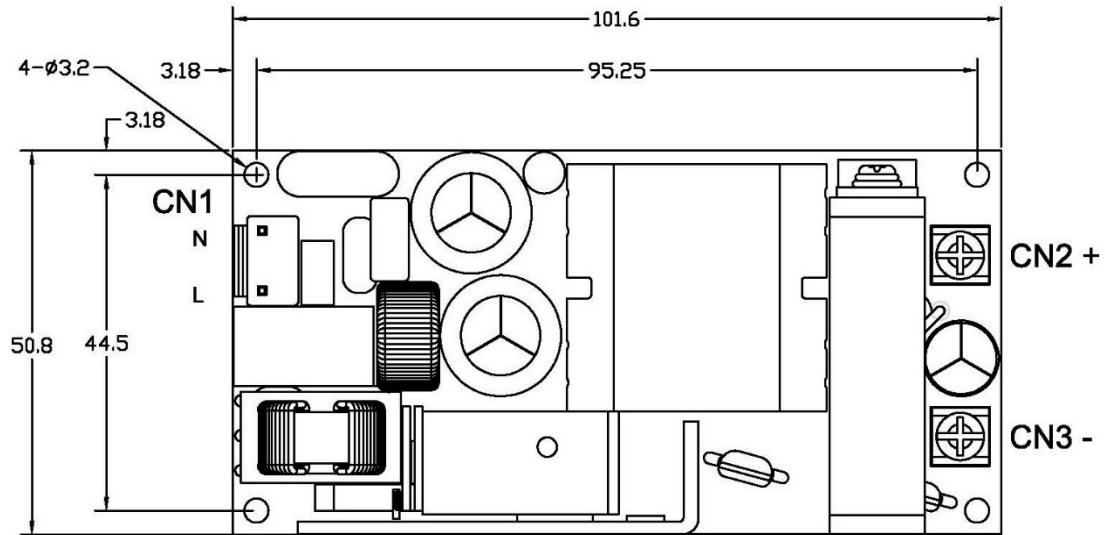

Parameter	Conditions/Description				
Dimension	101.6(L) x 50.8(W) x 37.6(H)mm, Tolerance +/-0.4mm.				
Connector & Pin Assignment	Location	Pin	Assignment	Proposed Housing	Proposed Terminals
	CN1 (Input)	1	AC in (L)	JST: VHR-3N or equivalent	JST:SVH-21T-P1-1 or equivalent
		2	AC in (N)		
	CN2 (Output)	1	+V	Dinkle P-820W Terminal blocks or equivalent	
CN3 (Output)	1	0V			



## Thermal Considerations

In order to ensure safe operation of the PSU in the end-use equipment, the temperature of the components listed in the table below must not be exceeded.

Temperature should be monitored using J type thermocouples placed on the hottest part of the component (out of any direct air flow). See Mechanical Details for component locations.

Temperature Measurements at max. Amb.	
Component	Max Temperature °C
C1	95
T1	110
L1	100
Q5	105
C12	80

## Performance

(Input voltage: 230Vac)

Switching frequency ripple rated load

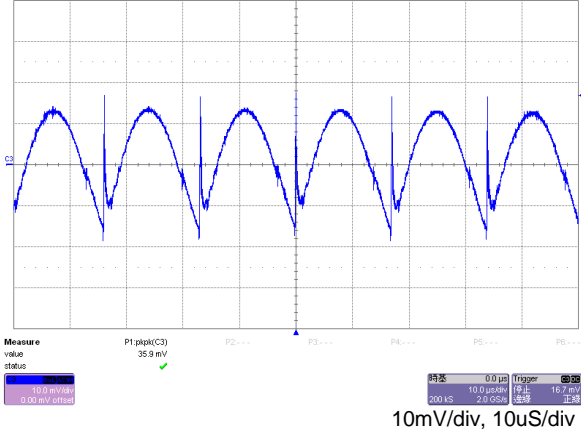

Line frequency ripple rated load

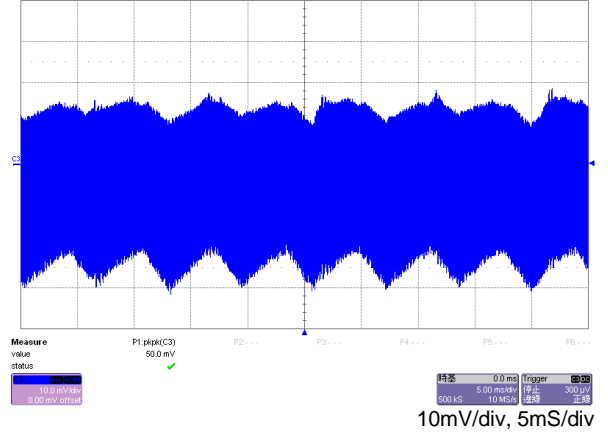

Output turn-on rated load

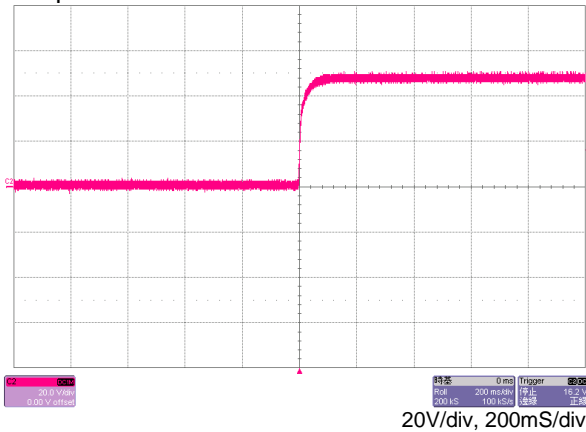

Output turn-off rated load

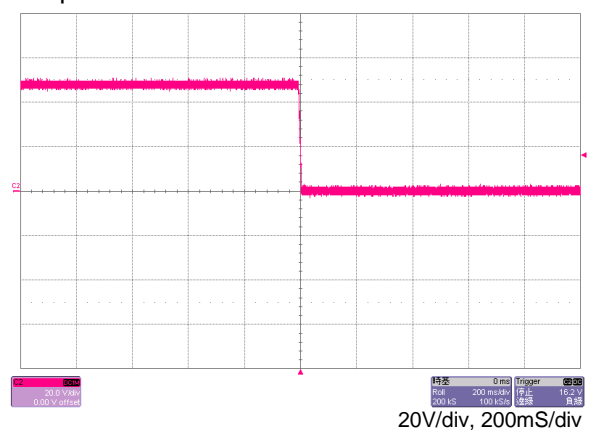

Hold-up time rated load

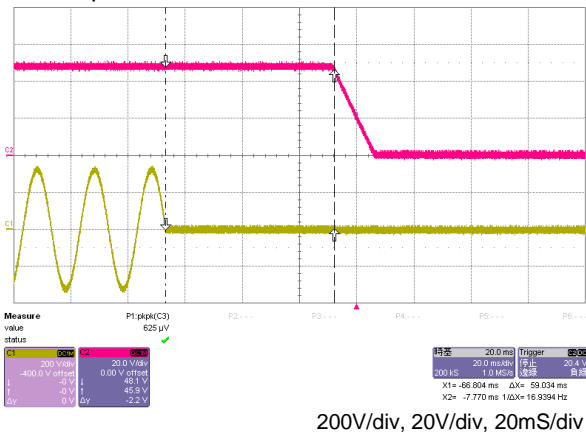

OVP 60% of rated load

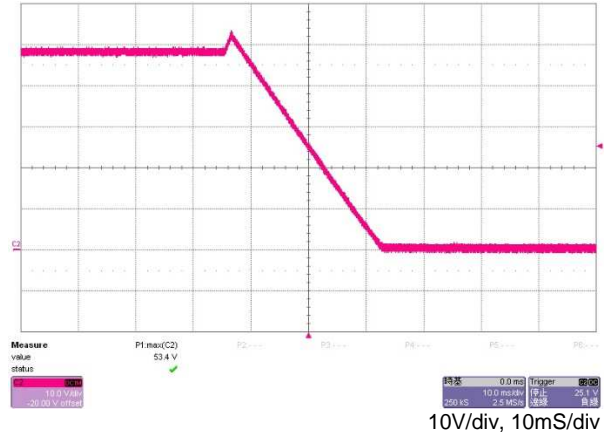

Step response (115V) 20%~100% of rated load

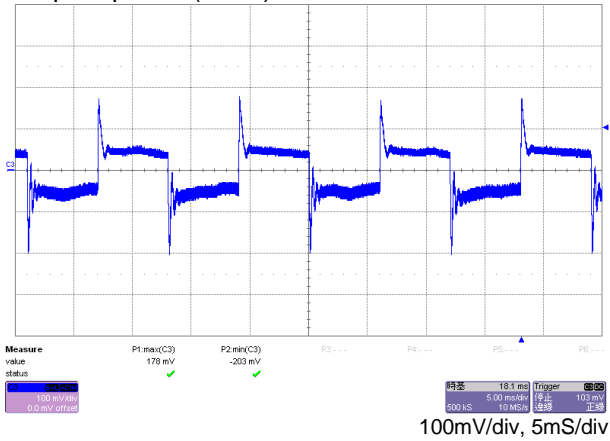

EMI: EN 55032 "B" (Conduction)

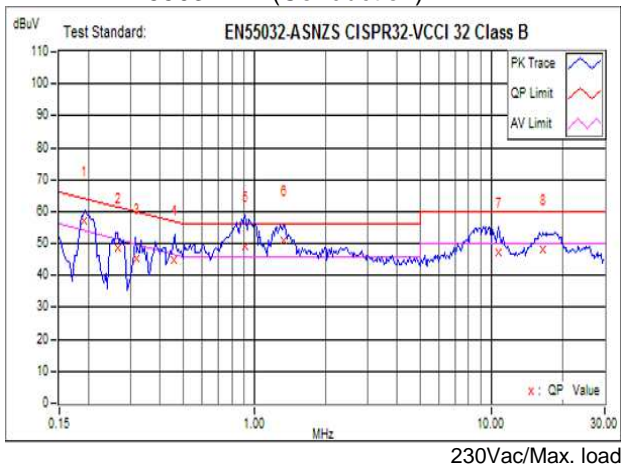

EMI: FCC "B" (Conduction)

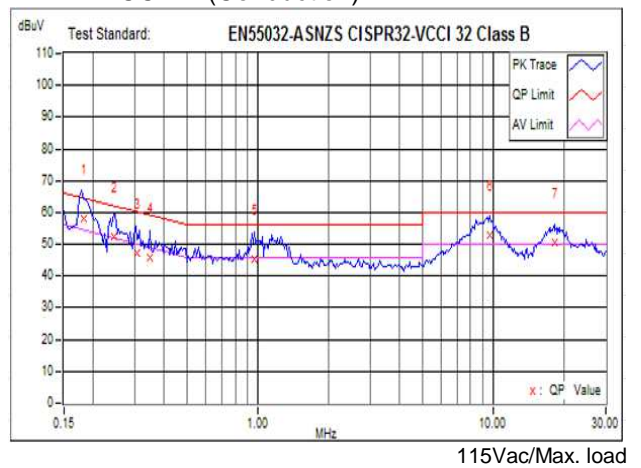

EMI: EN 55032 "B" (Radiation)

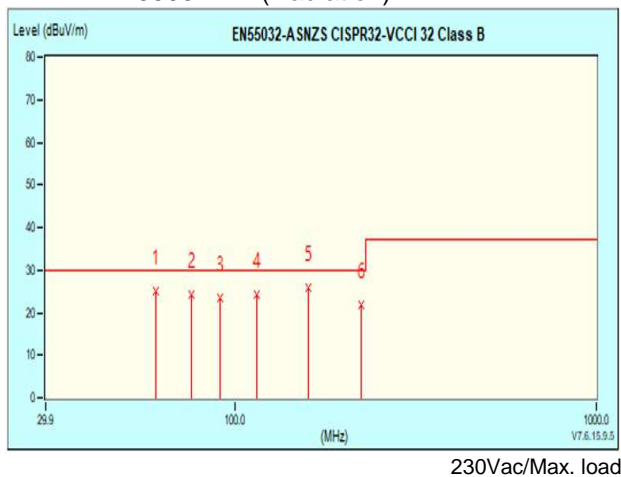

EMI: FCC "B" (Radiation)

