

SPECIFICATION

For

SWITCHING POWER SUPPLY

M/N: MPM-S126

Revision		
Version	Revise Date	Content
Rev. 01	Apr.19. 2017	Established.
Rev. 02	Aug.10.2017	Added Model no. coding and power factor.
Rev. 03	Aug.30.2017	Changed Mechanical drawing.
Rev. 04	Mar.12.2018	Changed EMC and Safety Approvals.

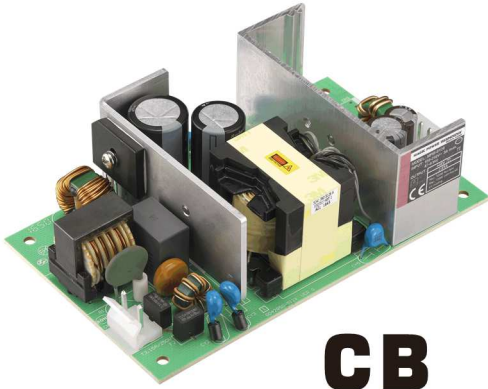

FEATURES

- ✓ 120W single fanless output with optional.
- ✓ Class II design for homecare equipment.
- ✓ Designed to meet medical standard EN / UL 60601-1 3.1 Edition.
- ✓ Meets EMI CISPR/FCC class B without metal enclosure shielding.
- ✓ 2 x MOPP
- ✓ Designed to meet IEC 60601-1-2 4th ed. EMC.
- ✓ No load power consumption is less than 0.5W.

Models & Ratings

Model Number	Wattage	Output 1				Output 2	
		Voltage	Min. Current	Rated Current	Max. Current	Voltage	Rated Current
MPM-S126	120 W	+48 V	0A	2.5 A	2.8A	-	-

Total Output Power: Max. 120W convection cooled, above 121~135W with 13.6 CFM forced air-cooling at 50°C environment temperature.
Please see detail performance curves as below.

Note:

2. Model no. coding:

M P M - S 1 2 X - Y - Z



1

X =	Output (V)
3	+12
5	+24
7	+36
6	+48

3

Z=	Input Connector Type	Output Connector Type
blank	Molex Type Connector or equivalent	Molex Type Connector or equivalent
J	JST Type Connector or equivalent	JST Type Connector or equivalent
Please refer to paragraph 8 for detail.		

2

Y =	Output set
Blank	Single output
SB	With +5Vsb & remote on/off function and PG/PF signal

Summary

Characteristic	Minimum	Typical	Maximum	Units	Notes & Conditions
Input Range	85	115 / 230	264	VAC	Universal input range.
Input Frequency	47	50 / 60	63	Hz	AC input.
Signals					
Efficiency		91%			At input 230VAC, rated load, 1.0 hr. warm up.
Operation Temperature	-20		+70	°C	Derate linearly from 50°C, become 50% load at 70°C.
Weight		270		g	
Dimensions	127 (L) x 76.2 (W) x 40.7 (H) mm, Tolerance +/- 0.5mm.				
EMC	EN 55011, EN 60601-1-2, EN 61000-3-2, EN 61000-3-3, IEC 61000-4-2, IEC 61000-4-3, IEC 61000-4-4, IEC 61000-4-5, IEC 61000-4-6, IEC 61000-4-8, IEC 61000-4-11				
Safety Approvals	IEC 60601-1, EN 60601-1				

Input

Characteristic	Minimum	Typical	Maximum	Units	Notes & Conditions
Input Voltage	85	115 / 230	264	VAC	Universal input range.
Input Frequency	47	50 / 60	63	Hz	AC input.
Input Current			3.0 / 1.5	A	Nominal AC Input Voltage (115VAC/230VAC), rated load.
Inrush Current			30 / 60	A	Nominal AC Input Voltage (115VAC/230VAC), one cycle at 25°C cold start.
Power Factor					
Leakage Current		100 / 300		μ A	Normal Condition / Single Fault Condition.
No-load power consumption		0.4/0.5		W	Nominal AC Input Voltage (115VAC/230VAC).
Power Factor		NA			
Input Protection	Dual non-user serviceable internally located AC input line fuse. Fuse : 3.15A / 250VAC * 2pcs				

Output

Characteristic	Minimum	Typical	Maximum	Units	Notes & Conditions
Output Voltage		48		VDC	
Initial Set Accuracy		± 1		%	Initial setting accuracy is adjusted at input 115VAC and output at 60% rated load.
Minimum Load		0		A	
Start Up Delay		1.5 / 1.0		sec	Time required for initial output voltage stabilization. Nominal AC Input Voltage (115VAC/230VAC), rated load at 25°C.
Hold Up Time	12 / 60	15 / 80		ms	Nominal AC Input Voltage (115VAC/230VAC), rated load.
Line Regulation		± 0.5		%	Less than $\pm 1\%$ at rated load with $\pm 10\%$ changing in input voltage.
Load Regulation		± 0.5		%	Measured from 60% to 100% rated load and from 60% to 20% rated load (60% $\pm 40\%$ rated load).
Ripple & Noise		240		mV	Measured at rated load by a 20MHz bandwidth limited oscilloscope and each output is connected with a 10 μ F Electrolytic Capacitor and a 0.1 μ F Ceramic Capacitor.
Overvoltage Protection	For some reason the power supply fails to control itself, the build-in over voltage protection circuit will shut down the outputs to prevent damaging external circuits.				
Overload Protection	Auto recovery.				
Short Circuit Protection	Fully protected against output overload and short circuit. Automatic recovery upon of overload condition.				
Remote On / Off	N/A				
Remote Sense	N/A				

General

Characteristic	Minimum	Typical	Maximum	Units	Notes & Conditions
Efficiency		91		%	At input 230VAC, rated load, 1.0 hr. warm up.
Isolation	IP to OP	2 x MOPP			
	IP to Ground	2 x MOPP			
	OP to Ground	1 x MOPP			
Switching Frequency		<65		kHZ	
MTBF		309,665		Hrs.	MIL-HDBK-217F at 50°C

Environmental

Characteristic	Minimum	Typical	Maximum	Units	Notes & Conditions
Low temperature start up	-30			°C	Some specification parameters maybe exceeded until after 20 minutes warm up period. <small>(Note 1)</small>
Operating Temperature	-20		+70	°C	Derate linearly above 50°C, performance curves will be provided after testing.
Storage Temperature	-40		+85	°C	
Relative Humidity	5		95	%RH	Non-condensing.
Cooling					Convection-cooled
Operating Altitude		5K		Meter	
Non-operating Altitude		5K		Meter	
Vibration	0.26		6.09	G	Frequency Type: Sweep Frequency Frequency Range: 10~55 Hz Displacement: 1.0mm Sweep Rate: 60 minute / cycle Number of cycle: 1 cycle / axis Direction: X ,Y and Z axis

Note:
1. To start up at low temperature, when the $V_{IP} < 115VAC$, please set the rated load @ 10% for maximum; when $115VAC < V_{IP} < 230VAC$, please set the rated load @ 30% for maximum; when $V_{IP} \geq 230VAC$, there will be no specific limitation on rated load setting.

Derating curve

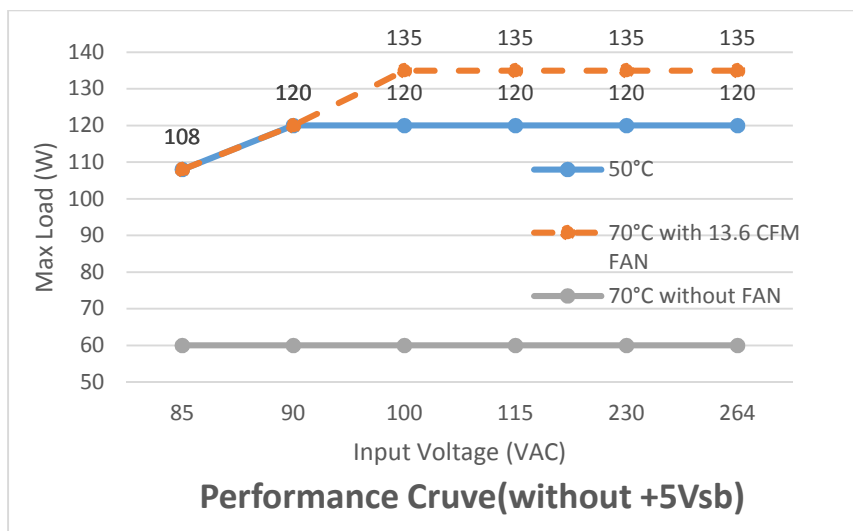

EMC: Emissions (Note 1,2)

Phenomenon	Standard	Class	Notes & Conditions
Conducted	EN 55011 / CISPR 11 & FCC Part 18	B	
Radiated	EN 55011 / CISPR 11 & FCC Part 18	B	
Harmonic Current	EN 61000-3-2	A	
Voltage Flicker	EN 61000-3-3		

- Note:
- For class II, the final assembly has to comply with the valid EMI/EMC and safety, can be assemble with plastic enclosure, if the information of metal enclosure is needed, please contact Magic Power.
 - Apply to output equal or below 120W, for higher output power, please re-confirm with us.

EMC: Immunity (Note 1.)

Phenomenon	Standard	Criteria	Notes & Conditions
ESD	IEC 61000-4-2	A	±15KV air discharge, ±8KV contact discharge
Radiated	IEC 61000-4-3	A	10V/m, 80 - 2700MHz
EFT	IEC 61000-4-4	A	±2KV Line & PE, 100KHz
Surges	IEC 61000-4-5	A	L-N:±1KV
Conducted	IEC 61000-4-6	A	10V
Power Magnetic	IEC 61000-4-8	A	30A/m
Dips and Interruptions	IEC 61000-4-11	A A / B A / B B	DIP: >95%, 0.5 cycle DIP: 30%, 25 cycles (Note 2) DIP: 60%, 5 cycles (Note 2) INT: >95%, 250 cycles

- Note:
- Apply to output equal or below 120W, for higher output power, please re-confirm with us.
 - The test result of input 240Vac / 100Vac is criteria A / B.

Safety Approvals

Safety Agency	Safety Standard	Notes & Conditions
TUV	EN 60601-1:2005+A11+A1+A12	Designed to meet.
CB	IEC 60601-1:2005+A1	Approved (Medical 3.1 rd)
UL/cUL	ANSI/AAMI ES60601-1, CAN/CSA-C22.2 No. 60601-1	Designed to meet.

Mechanical Details

SIZE : 127.0(L) x 76.2(W) x 40.7(H)mm, Tolerance +/-0.5mm.

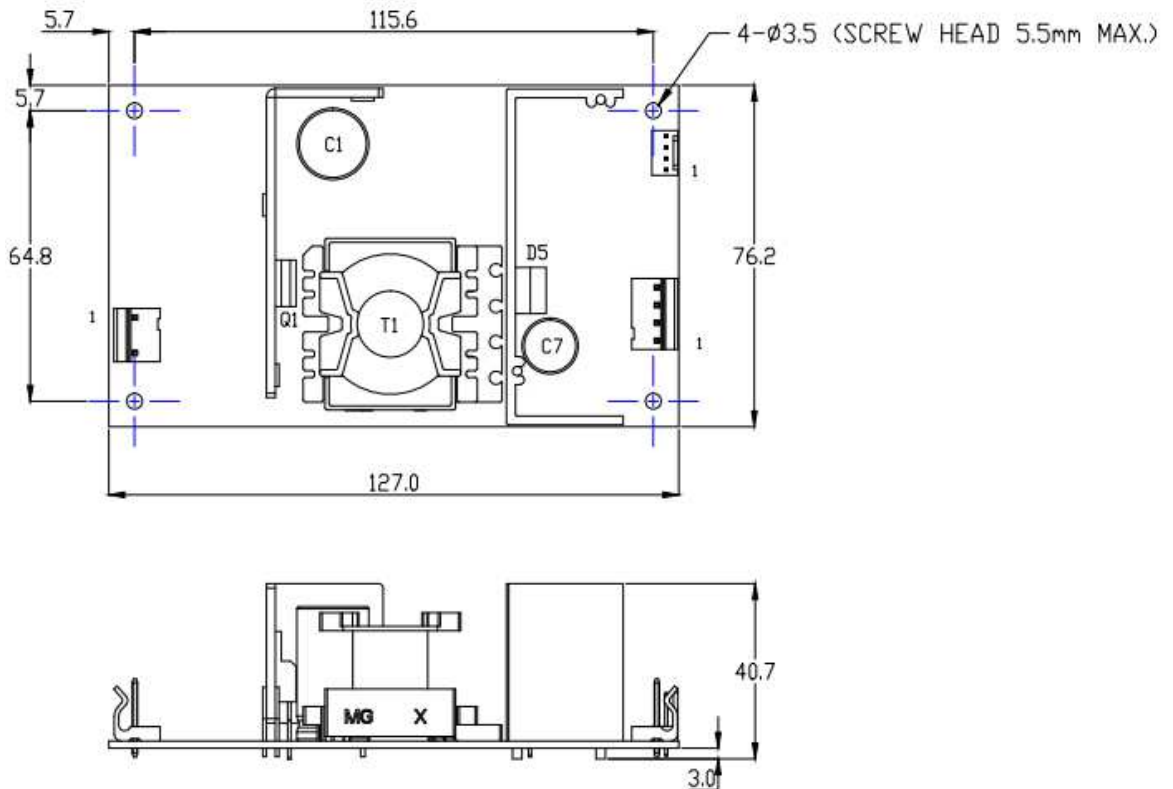

Input Connector CN1	
Pin 1	Line
Pin 2	Empty
Pin 3	Neutral

Mates with Molex 09-50-1031 and Molex series 5194 crimp terminals or Equivalent.

When used model no. suffixed -J mates with JST VHR-3N and JST series SVH-21T-P1.1 crimp terminals or Equivalent.

Output Connector CN2	
Pin 1	+V
Pin 2	+V
Pin 3	GND
Pin 4	GND

Mates with Molex 09-50-1041 and Molex series 5194 crimp terminals or Equivalent.

When used model no. suffixed -J mates with JST VHR-4N and JST series SVH-21T-P1.1 crimp terminals or Equivalent.

Signal Connector CN3	
Pin 1	+5Vsb
Pin 2	GND
Pin 3	ON/OFF
Pin 4	PG/PF

*Optional

Mates with Molex 22-01-1042 and Molex series 2759 crimp terminals or Equivalent.

When used model no. suffixed -J mates with JST XHP-4 and JST series SXH-001T-P0.6N or SXH-001T-P0.6 or SXH-002T-P0.6 crimp terminals or Equivalent.

Note:
This specification is not as a sale and purchase agreement.

Performance

(Input voltage: 115Vac)

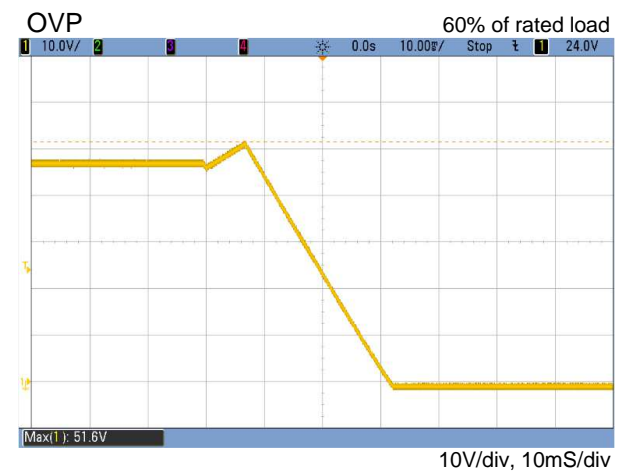
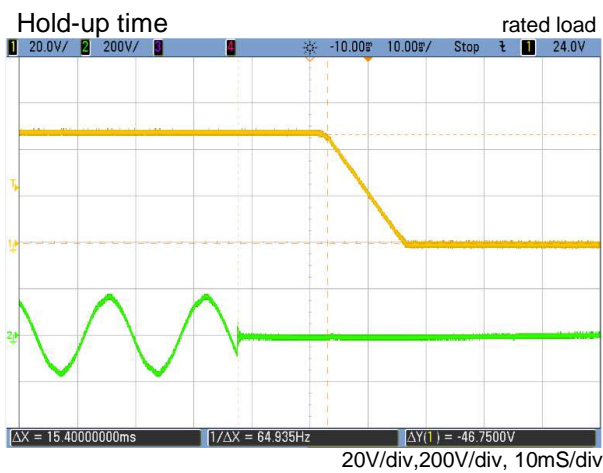
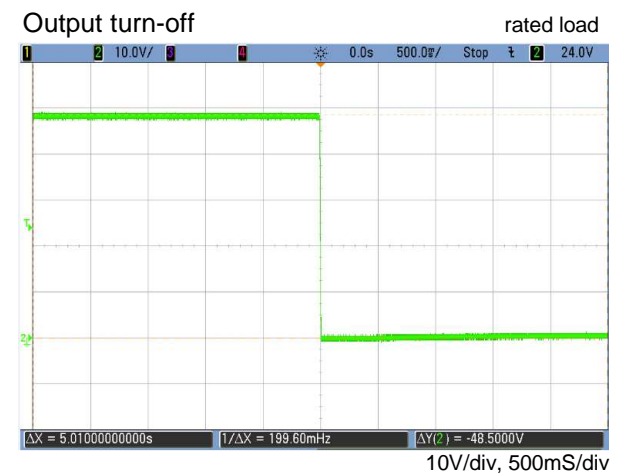
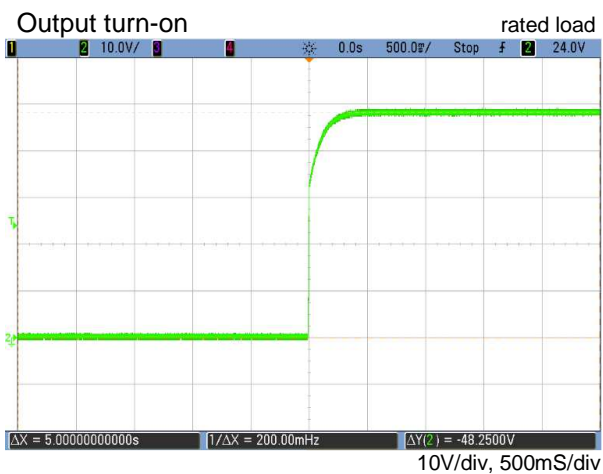
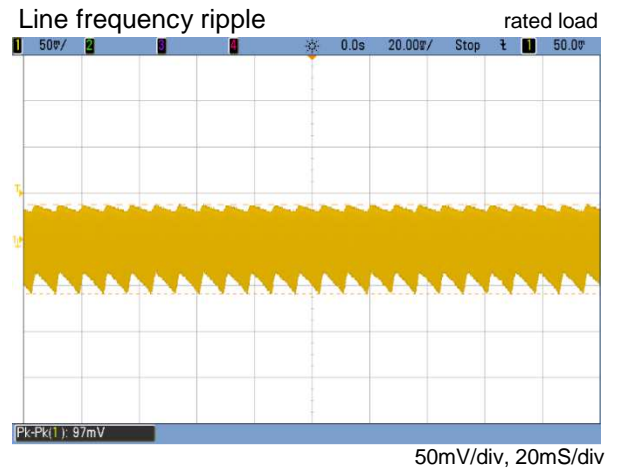
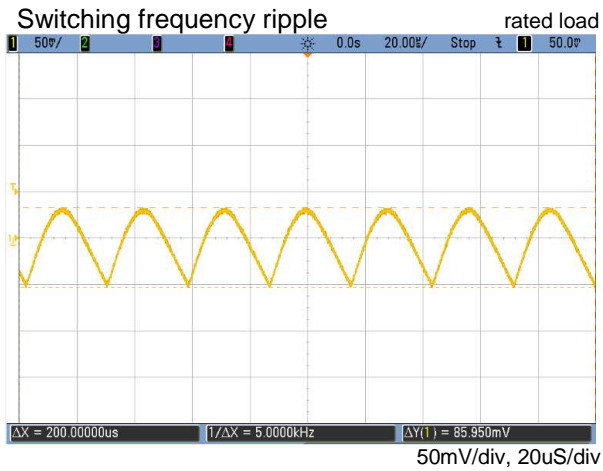

Performance

Step response 20%~100% of rated load



EMI: EN55011 "B" (Conduction)

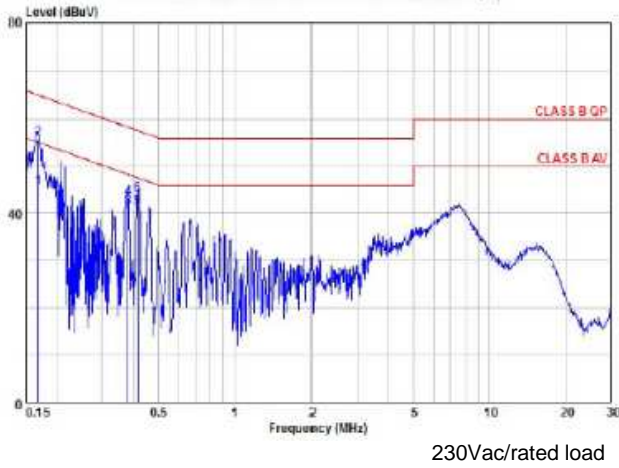

EMI: FCC "B" (Conduction)

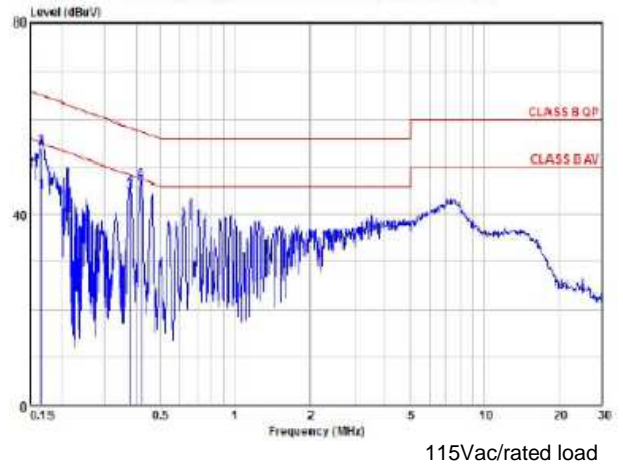

EMI: EN55011 "B" (Radiation)

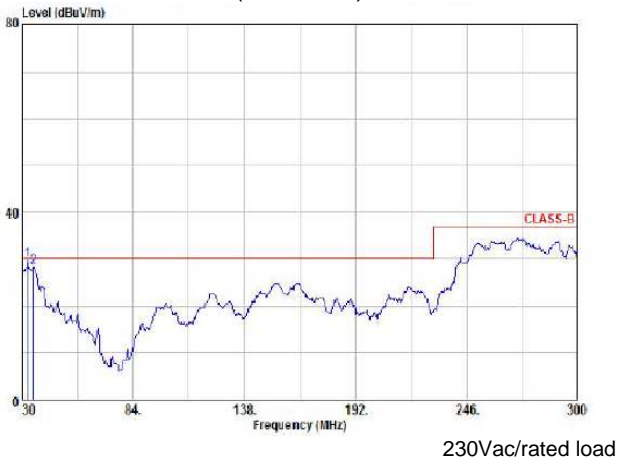

EMI: FCC "B" (Radiation)

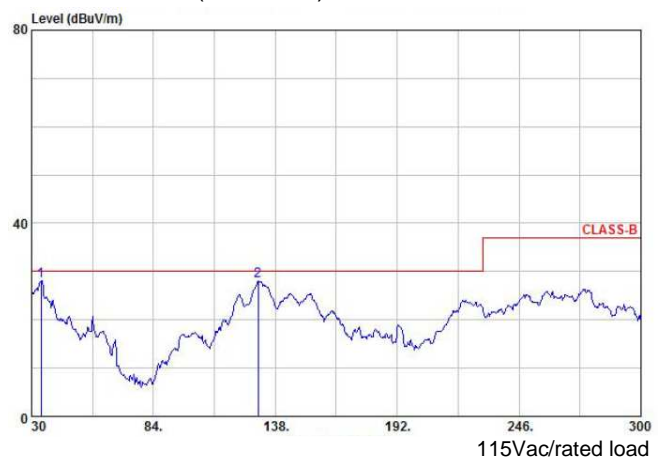

Thermal Considerations

In order to ensure safe operation of the PSU in the end-use equipment, the temperature of the components listed in the table below must not be exceeded.

Temperature should be monitored using J type thermocouples placed on the hottest part of the component (out of any direct air flow). See Mechanical Details for component locations.

Temperature Measurements at max. amb.	
Component	Max Temperature
T1	110°C
Q1	120°C
D5	120°C
C1	105°C
C7	105°C